



SUBJECT: SCE 310 - Equipment for calibration of radar sensors

The continuous growth of new in-vehicle ADAS sensors and the marketing of new vehicles require a constant updating of equipment to guarantee and facilitate the correct calibration of sensors.



In this context of constant evolution, we created the new **SCE 310**, the equipment for the calibration of Radar sensors installed in the new generation vehicles of Toyota, Lexus, Mazda, Kia and Hyundai manufacturers.

Compared with the previous SCE 300 model, the **advantages** of the new SCE 310 are:

- reflector can be rotated for easier positioning
- laser blade support calibration to offer greater positioning precision
- modular floor pads kit to be positioned at the sides, according to car manufacturer's specifications (Patented)
- additional alignment templates to cover all cases nowadays required by car manufacturers

The main features of the SCE 310 equipment are listed below:

Intuitive (Plug & Play)

The software guides the operator through the different system alignment procedures so that any positioning error is avoided.

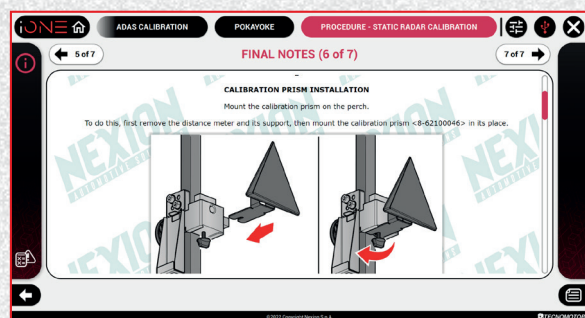
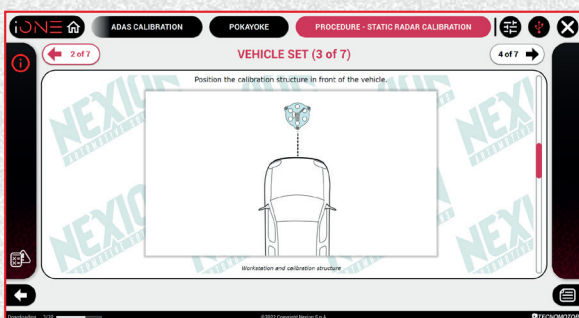

Real-time positioning control

Equipment rapidly positioned thanks to values measured by the laser pointer in real time.

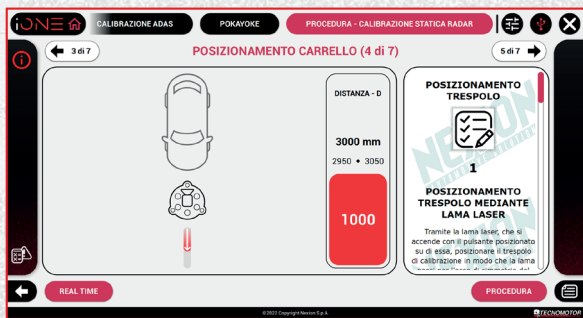

Accurate

Maximum precision in positioning the equipment thanks to the laser blade and reflector support that can be adjusted in accordance with the car manufacturer's specifications.

Compatible with OEM and Multi-brand Official Diagnosis

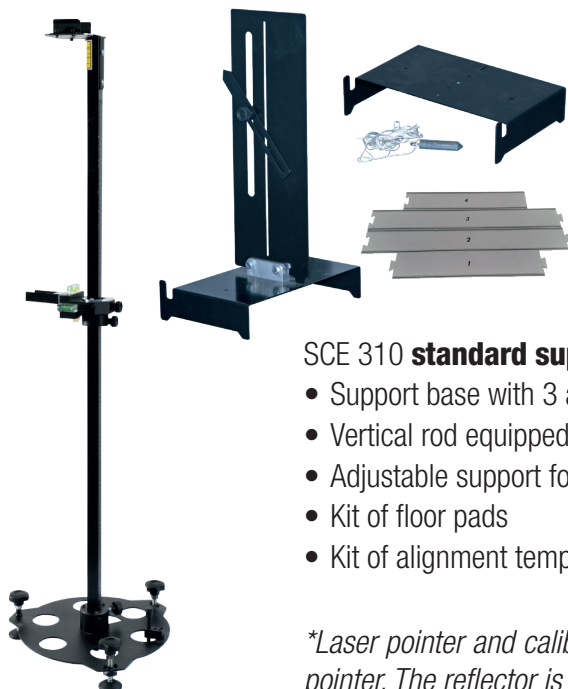



SCE 310 **standard supply** includes:

- Support base with 3 adjustable feet
- Vertical rod equipped with adhesive millimetre scale plate
- Adjustable support for laser pointer* and calibration reflector*
- Kit of floor pads
- Kit of alignment templates

*Laser pointer and calibration reflector not included; PROADAS system owners can use the same pointer. The reflector is required to carry out calibration.

SCE 310 is already available for sale, the code to be used for orders is: **0-62103201/91**.

Optional accessories:

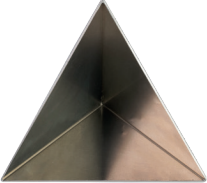
| | | |
|---|---|-------------------|
|  | <p>Line laser pointer**</p> | <p>8-62100064</p> |
|  | <p>Type 1 reflector: Toyota, Lexus</p> | <p>8-62100046</p> |
|  | <p>Type 2 reflector: Kia, Hyundai and Mazda</p> | <p>8-62100047</p> |

** PROADAS system owners can use the same pointer

For any further information, please download the **brochure** from our website: **SCE 310**.

